

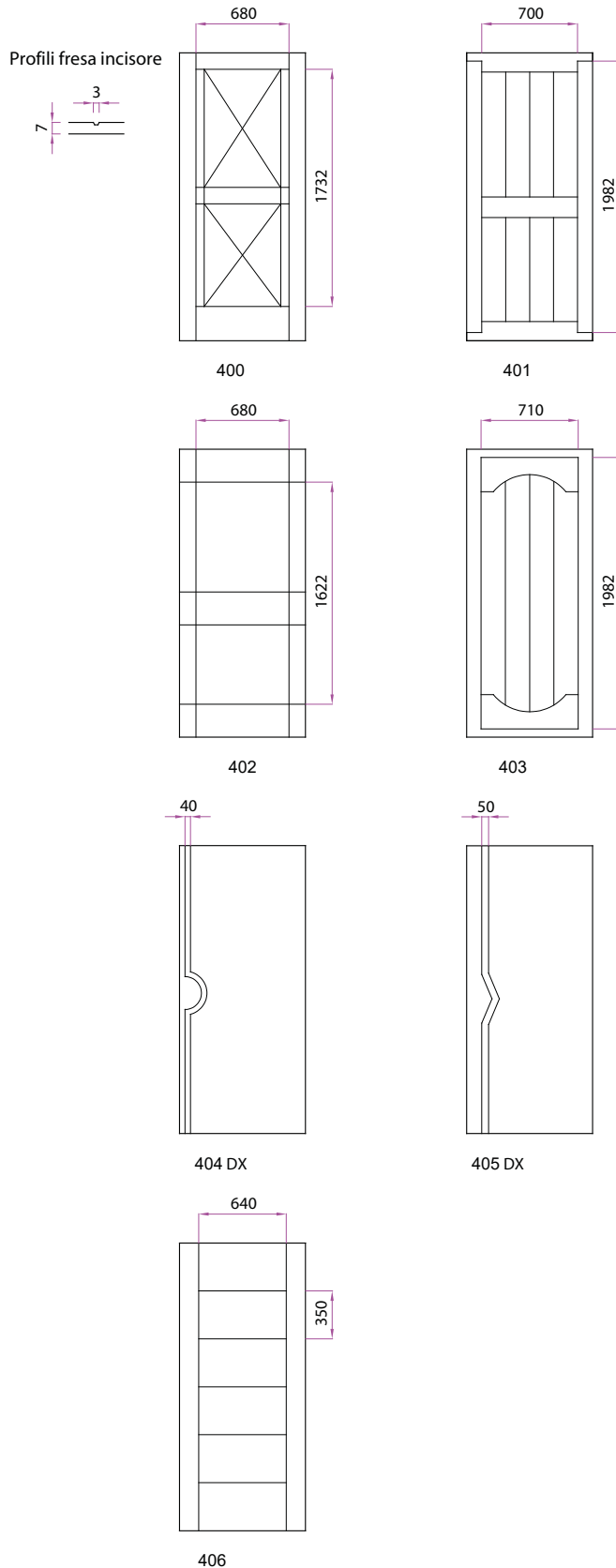

OBELIX RIVESTIMENTI EDISON

PER INTERNO

La lavorazione di incisione si può fare solo su pannelli laminatino liscio, fin itura legno con base MDF. Una volta inciso, sul pannello rimane a vista la base MDF che verrà sottoposta ad una fase di verniciatura trasparente.



Modello: **400**
 Materiale: **Laminatino**
 Colore: **tanganica naturale leggermente tinto**



NOTA: La lavorazione di incisione non è possibile su laminatini con vene a rilievo e pannelli laccati.

PER INTERNO

I pannelli EDISON possono essere posati esclusivamente all'interno in ambiente chiuso, sono una valida alternativa ai pannelli lisci. Li proponiamo solo impiallacciati in essenze nobili (Noce, Tanganica, Rovere, Radica, ecc.). Conservano una lavorazione artigianale e portano in dote una naturale eleganza.



Modello: **301**
 Essenza: **Tanganica**
 Colore: **naturale**

Varianti: **Rovere**



Modello: **304**
 Essenza: **Rovere**
 Colore: **naturale**

Varianti: **Tanganica, Mogano**





Modello: **305**
Essenza: **Tanganica e Radica**
Colore: **naturale**

Varianti: **Rovere**



Modello: **308**
Essenza: **Tanganica**
Colore: **naturale**

Varianti: **Rovere**





Modello: **306**
Essenza: **Tanganica**
Colore: **naturale**
Varianti: **Rovere, Mogano**



Modello: **307**
Essenza: **Tanganica**
Colore: **naturale**
Varianti: **Rovere, Mogano**





Modello: **330**
Essenza: **Zebrano**
Colore: **naturale**



Modello: **315**
Essenza: **Tanganica**
Colore: **naturale**

Varianti: **Rovere, Mogano**





Modello: **327**
Essenza: **Rovere**
Colore: **tinto wengè**
Inserti: **chromo satinati**



Modello: **329**
Essenza: **Rovere**
Colore: **sbiancato**
Inserti: **chromo satinati**





Modello: **309**
 Essenza: **Rovere**
 Colore: **tinto wengè**
 Inserti: **cromo satinati**



Modello: **309**
 Essenza: **Rovere**
 Colore: **sbiancato**
 Inserti: **cromo satinati**



Modello: **309**
 Essenza: **Rovere**
 Colore: **naturale**
 Inserti: **cromo satinati**



Modello: **309**
 Essenza: **MDF**
 Colore: **Laccato bianco**
 Inserti*: **cromo satinati**



Nota: *L'inserto viene inserito dopo la verniciatura a differenza degli altri pannelli del modello 309.

DISEGNI PANNELLI EDISON

spessore mm 7

Nei disegni si possono notare delle linee più marcate: sono i filetti di interposizione tra le impiallacciate. I filetti di colore nero o marrone sono realizzati in Tulipier, quelli chiari sono realizzati in Acero o Rovere.

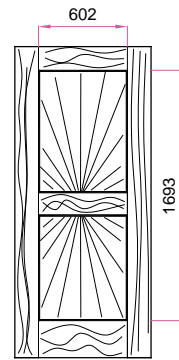

301

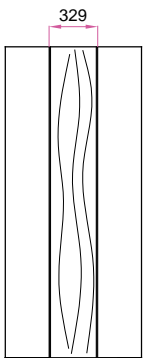

302

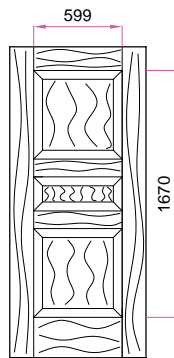

303

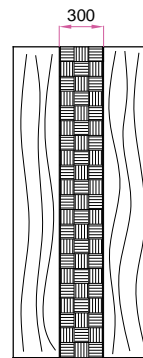

304

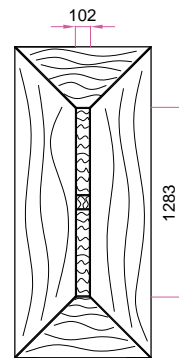

305

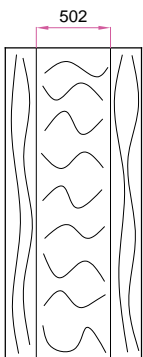

308

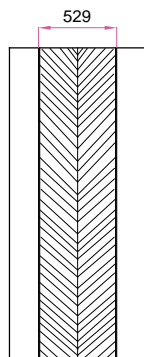

306

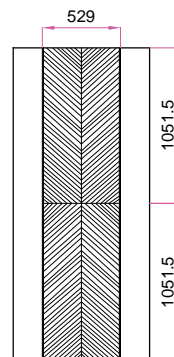

307

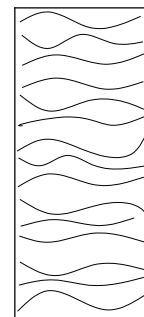

330

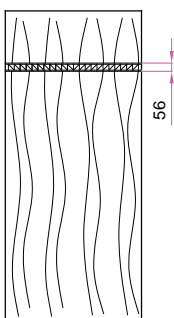

328

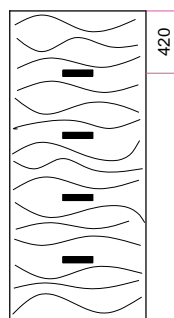

329

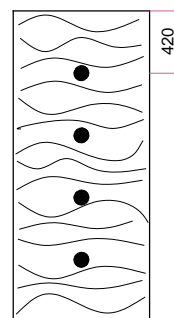

327

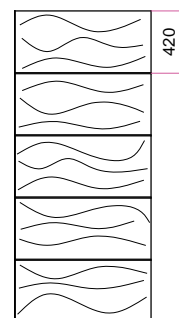

309

NOTA: I modelli 327, 329 e 309 sono realizzati con inserti cromo satinati.

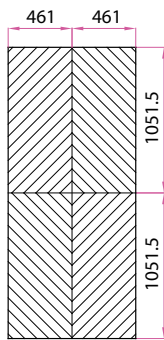

311

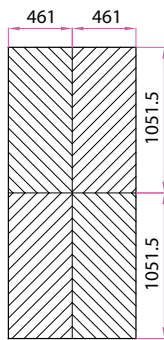

312

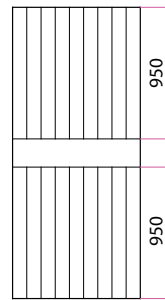

313

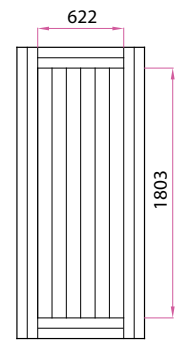

314

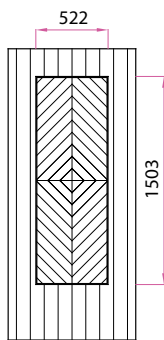

315

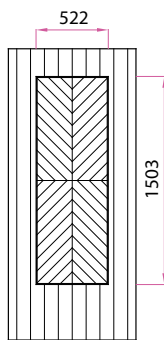

316

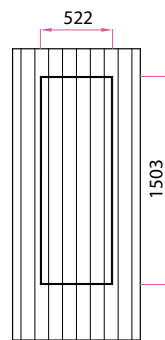

317

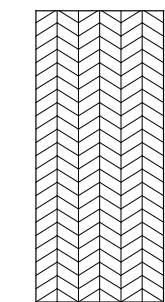

153
318

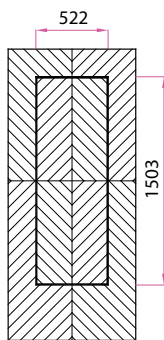

319

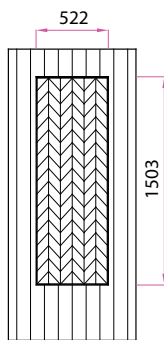

320

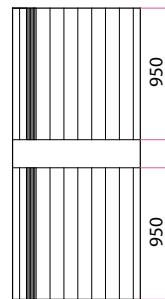

321

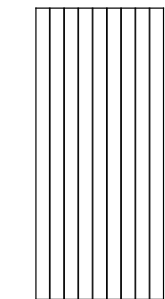

100
322

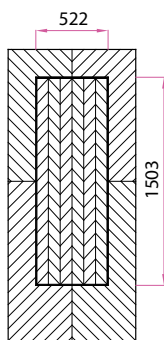

323

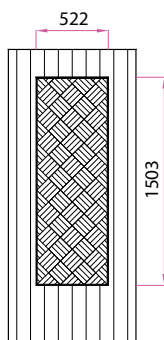

324

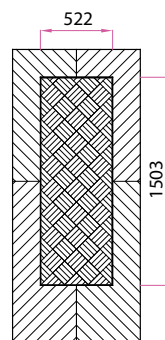

325

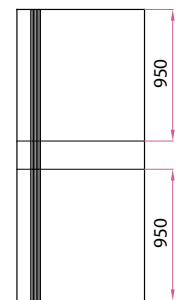

70
950
950
326

NOTE: Tutti i disegni sono per porte blindate di luce netta 90x210, cambiando le misure i disegni hanno delle variazioni nelle proporzioni. Possiamo realizzare pannelli EDISON a campione previa verifica fattibilità. Fascia di rispetto dal bordo per maniglia mm 140.